

TECHNICAL DATA:

According to standard EN 1176-1:2017

Device dimensions: 0,70 x 2,10m
 Device height: 0,70m

The device according to EN 1176-1:2017
 Playground equipment and surfacing – Part 1:
 General safety requirements and test methods

Projection and device view

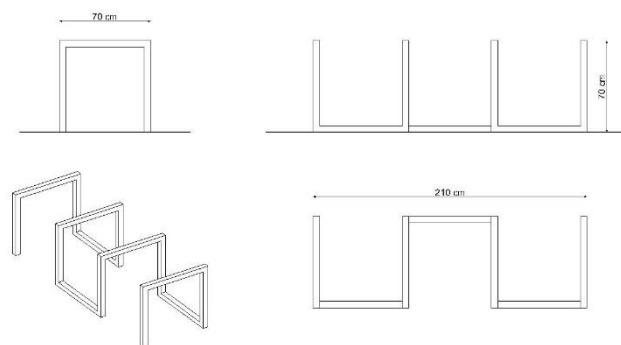

MATERIALS:

Construction: galvanized steel, powder coated



GRUPA SATERNUS. S.A.
 ul. Nowa 32
 41-500 Chorzów, Poland

Certificate beholder:
 Producer:
 Distributor:

GRUPA SATERNUS S. A. reserves all rights to protect copyright
 Under the Act of February 4, 1994 on Copyright and Related Rights
 (Journal of Laws No. 28, pc 83), and in particular Art. 78 and 79 of this Law.

GRUPA SATERNUS S.A.
 Saternus Production Sp. z o.o. sp. k.
 Saternus Distribution Sp. z o.o. sp. k.