



TECHNICAL DATA:

Equipment for users with overall height greater than 140cm

Top view with falling area

Device dimensions:	0,80 x 0,63m
Device height:	1,35m
Minimum space:	3,80 x 3,63m
Falling area:	11,54m ²
Critical fall height:	0,60m
Foundations depth:	-0,70m

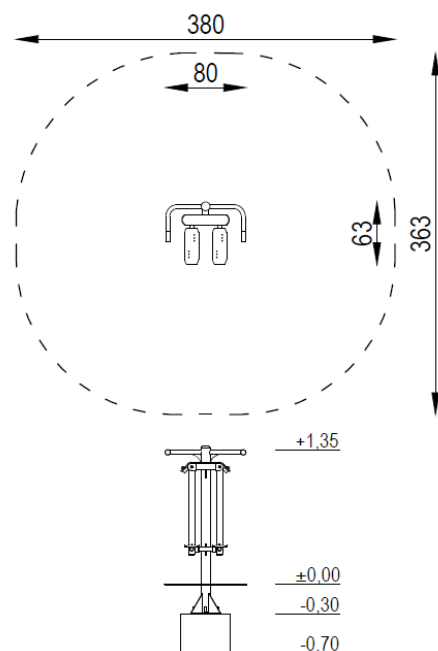

The device according to:
EN 16630 Permanently installed outdoor fitness equipment -
Safety requirements and test methods

Safety surfaces:

- paved, turf / topsoil, sand, gravel, bark, synthetic surface
- minimal thickness for loose particulate materials
200+100mm
- synthetic surface according to critical fall height

MATERIALS:

Construction: steel profiles and plate, galvanized, powder coated
Caps: plastic
Foundations: concrete min. C20/25 standard



GRUPA SATERNUS S.A.
ul. Nowa 32
41-500 Chorzów, Poland

Certificate beholder:
Producer:
Distributor:

GRUPA SATERNUS S.A. reserves all rights to protect copyright
Under the Act of February 4, 1994 on Copyright and Related Rights
(Journal of Laws No. 28, pc 83), and in particular Art. 78 and 79 of this Law.

GRUPA SATERNUS S.A.
Saternus Production Sp. z o.o. sp. k.
Saternus Distribution Sp. z o.o. sp. k.