



### TECHNICAL DATA:

Equipment for users with overall height greater than 140cm

#### Top view with falling area

Device dimensions:	1,85 x 0,71m
Device height:	1,75m
Minimum space:	4,85 x 3,71m
Falling area:	15,61m <sup>2</sup>
Critical fall height:	0,60m
Foundations depth:	-0,70m

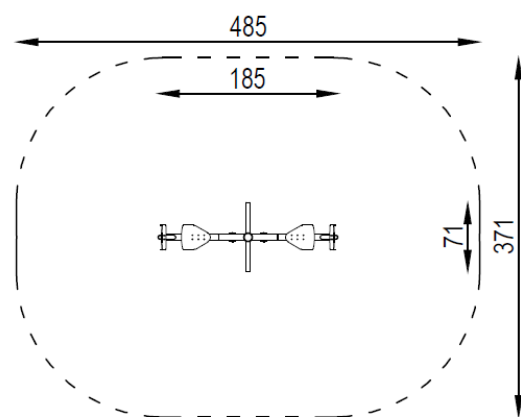

The device according to:

EN 16630 Permanently installed outdoor fitness equipment -  
Safety requirements and test methods

Safety surfaces:

- paved, turf / topsoil, sand, gravel, bark, synthetic surface
- minimal thickness for loose particulate materials  
200+100mm
- synthetic surface according to critical fall height

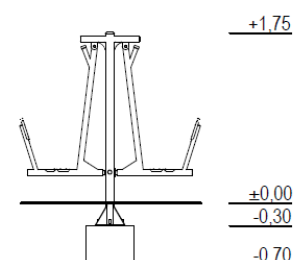

## MATERIALS:

Construction: steel profiles and plate, galvanized, powder coated  
Caps: plastic  
Foundations: concrete min. C20/25 standard



GRUPA SATERNUS S.A.  
ul. Nowa 32  
41-500 Chorzów, Poland

Certificate beholder:  
Producer:  
Distributor:

GRUPA SATERNUS S.A. reserves all rights to protect copyright  
Under the Act of February 4, 1994 on Copyright and Related Rights  
(Journal of Laws No. 28, pc 83), and in particular Art. 78 and 79 of this Law.

GRUPA SATERNUS S.A.  
Saternus Production Sp. z o.o. sp. k.  
Saternus Distribution Sp. z o.o. sp. k.